



PJM90H03NTF

N-Channel Enhancement Mode Power MOSFET

Features

- Fast Switching
- Low Reverse transfer capacitances
- $V_{DS} = 900V, I_D = 3A$
 $R_{DS(on)} < 5\Omega @ V_{GS} = 10V$

Applications

- Power switch circuit of adaptor and charger

TO-220F

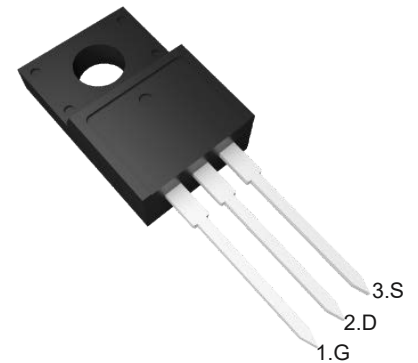

1.Gate 2.Drain 3.Source

Schematic diagram

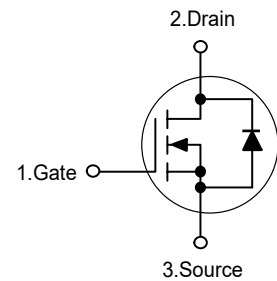

Absolute Maximum Ratings

Ratings at 25°C case temperature unless otherwise specified.

Parameter	Symbol	Value	Unit
Drain-Source Voltage	V_{DS}	900	V
Gate-Source Voltage	V_{GS}	± 30	V
Drain Current-Continuous	I_D	3	A
Drain Current-Pulsed ^{Note1}	I_{DM}	12	A
Single pulse avalanche energy ^{Note3}	E_{AS}	125	mJ
Maximum Power Dissipation	P_D	30	W
Junction Temperature	T_J	150	°C
Storage Temperature Range	T_{STG}	-55 to +150	°C

Thermal Characteristics

Thermal Resistance, Junction-to-Ambient	$R_{\theta JA}$	62	°C/W
Maximum Junction-to-Case	$R_{\theta JC}$	1.67	°C/W



PJM90H03NTF

N-Channel Enhancement Mode Power MOSFET

Electrical Characteristics

(T_C=25°C unless otherwise specified)

Parameter	Symbol	Test Condition	Min.	Typ.	Max.	Unit
Static Characteristics						
Drain-Source Breakdown Voltage	V _{(BR)DSS}	V _{GS} =0V, I _D =250μA	900	--	--	V
Zero Gate Voltage Drain Current	I _{DSS}	V _{DS} =900V, V _{GS} =0V	--	--	1	μA
Gate-Body Leakage Current	I _{GSS}	V _{GS} =±30V, V _{DS} =0V	--	--	±100	nA
Gate Threshold Voltage ^{Note2}	V _{GS(th)}	V _{DS} =V _{GS} , I _D =250μA	2.0	--	4.0	V
Drain-Source On-Resistance ^{Note2}	R _{DS(on)}	V _{GS} =10V, I _D =1.5A	--	4.2	5	Ω
Forward Transconductance ^{Note2}	g _{FS}	V _{DS} =15V, I _D =3A	--	5	--	S
Dynamic Characteristics						
Input Capacitance	C _{iss}	V _{DS} =25V, V _{GS} =0V, f=1MHz	--	630	--	pF
Output Capacitance	C _{oss}		--	44	--	pF
Reverse Transfer Capacitance	C _{rss}		--	6.5	--	pF
Switching Characteristics						
Turn-on Delay Time	t _{d(on)}	V _{DD} =450V, I _D =3A V _{GS} =10V, R _G =25Ω	--	13	--	nS
Turn-on Rise Time	t _r		--	32	--	nS
Turn-off Delay Time	t _{d(off)}		--	25	--	nS
Turn-off Fall Time	t _f		--	40	--	nS
Total Gate Charge	Q _g	V _{DD} =450V, I _D =3A, V _{GS} =10V	--	16	--	nC
Gate-Source Charge	Q _{gs}		--	4	--	nC
Gate-Drain Charge	Q _{gd}		--	7	--	nC
Source-Drain Diode Characteristics						
Diode Forward Voltage ^{Note2}	V _{SD}	V _{GS} =0V, I _S =3A	--	--	1.5	V
Diode Forward Current	I _S		--	--	3	A

Note: 1. Repetitive Rating: Pulse width limited by maximum junction temperature.

2. Pulse Test: Pulse width<380μs, duty cycle<2%.

3. E_{AS} Condition: L=10mH, I_D=4.9A, start T_J=25°C.



PJM90H03NTF

N-Channel Enhancement Mode Power MOSFET

Typical Characteristic Curves

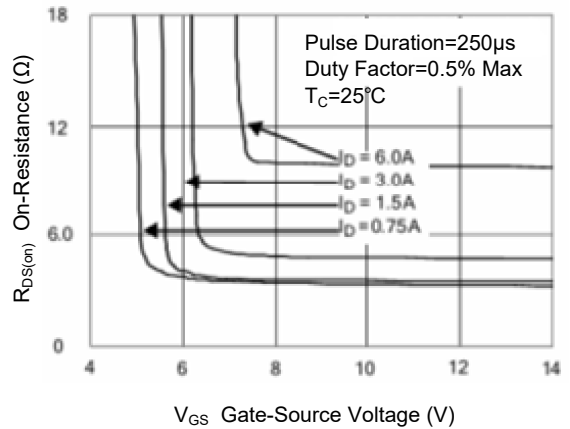
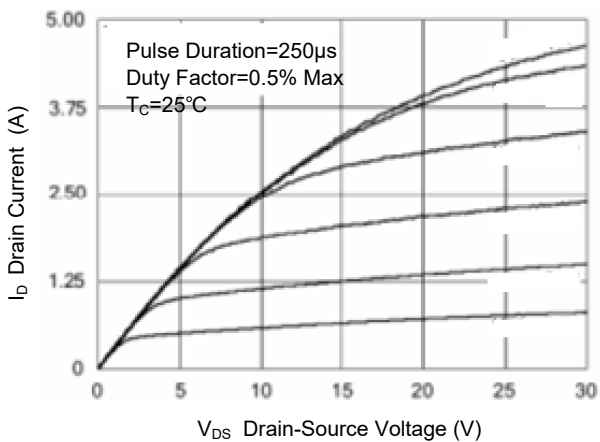
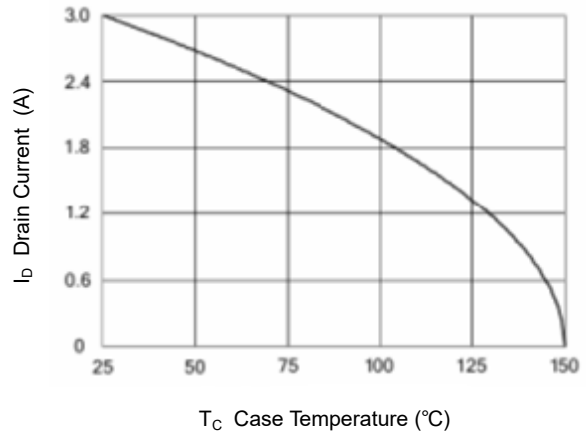
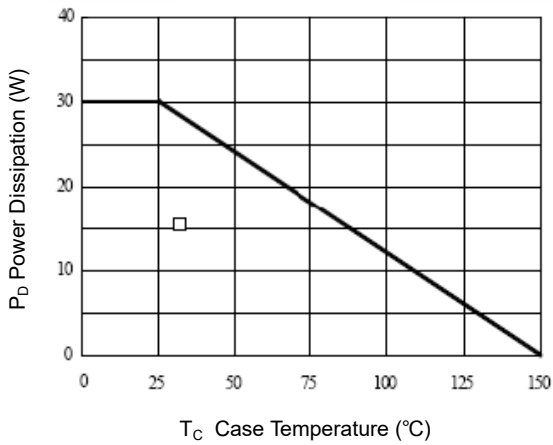
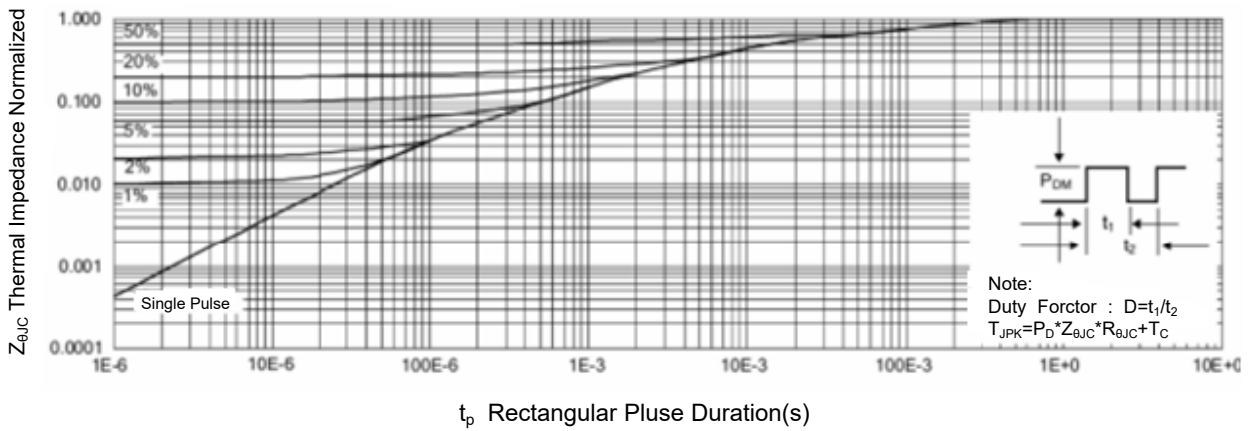



PJM90H03NTF

N-Channel Enhancement Mode Power MOSFET

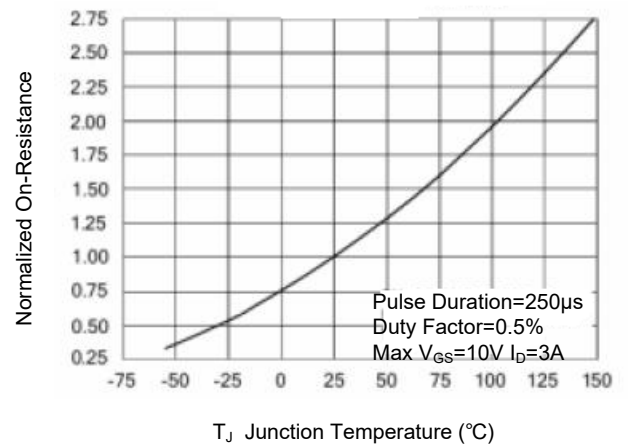
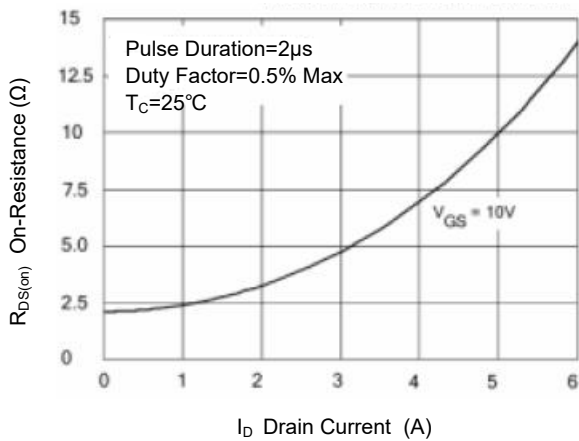
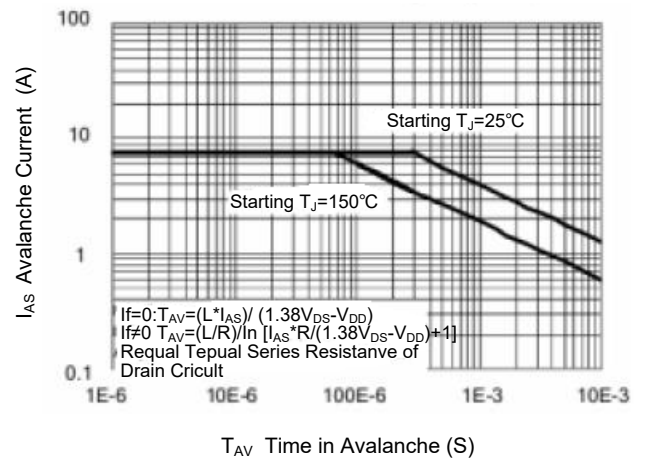
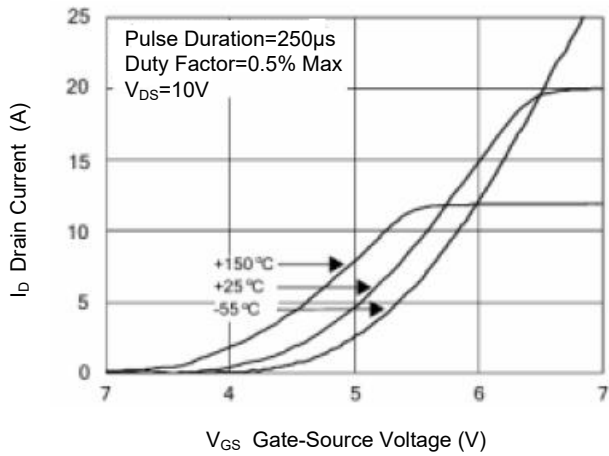
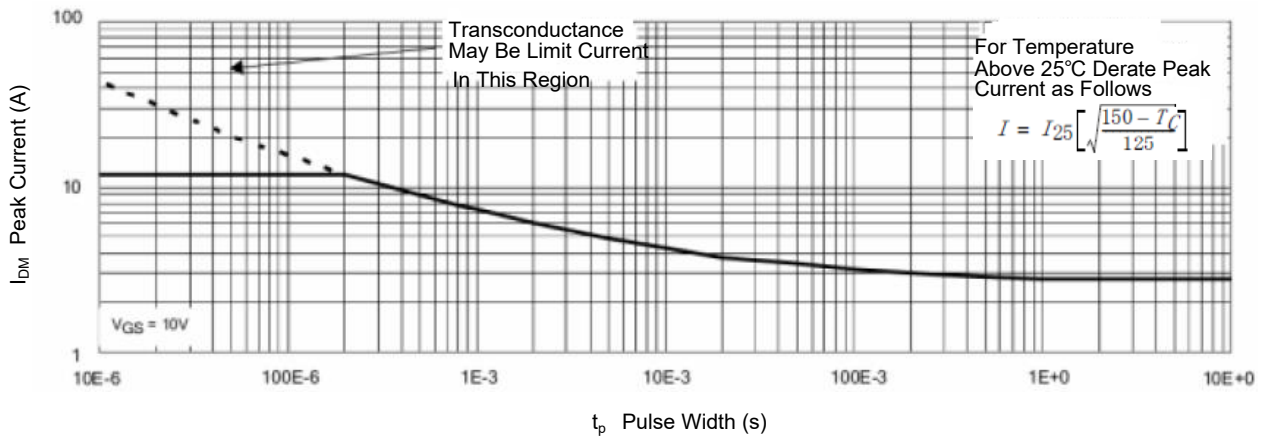



PJM90H03NTF

N-Channel Enhancement Mode Power MOSFET

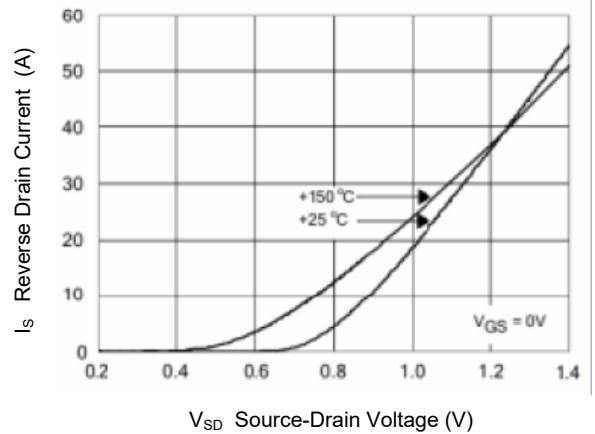
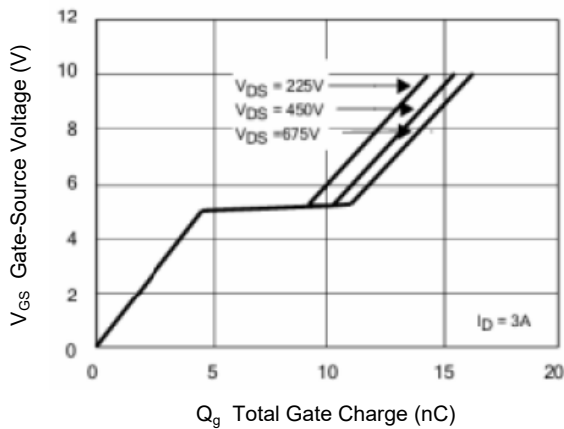
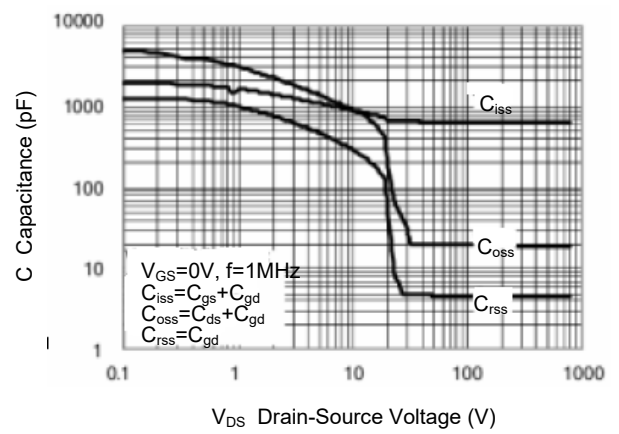
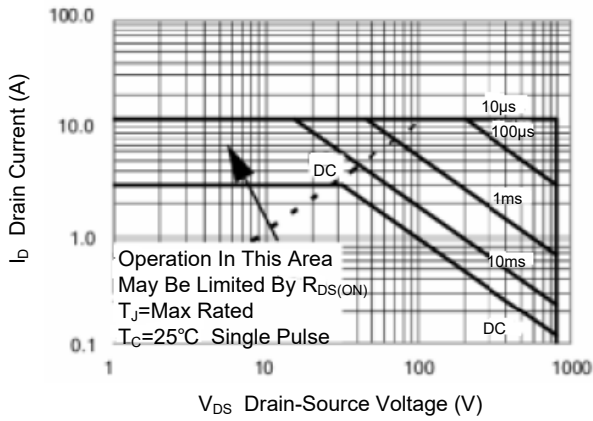
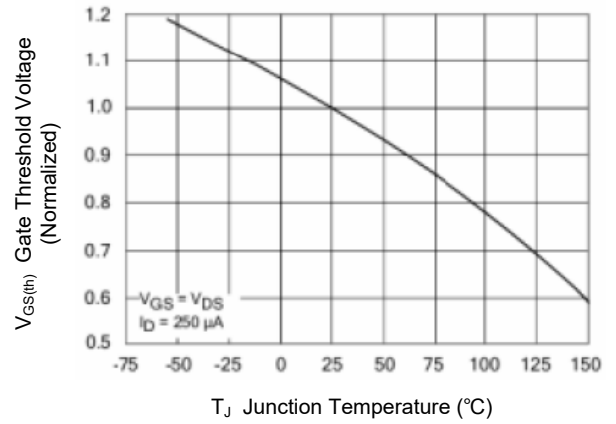
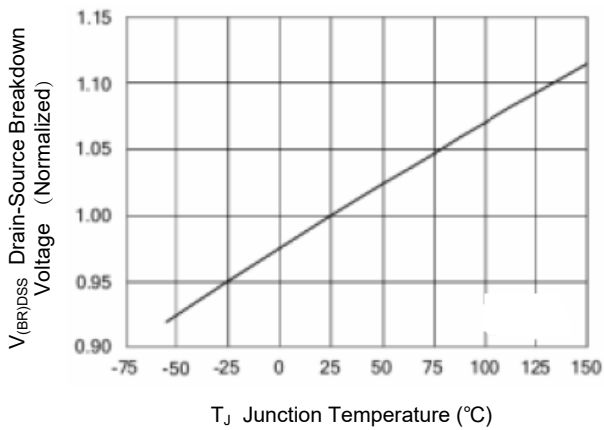



PJM90H03NTF

N-Channel Enhancement Mode Power MOSFET

Package Outline

TO-220F

Dimensions in mm

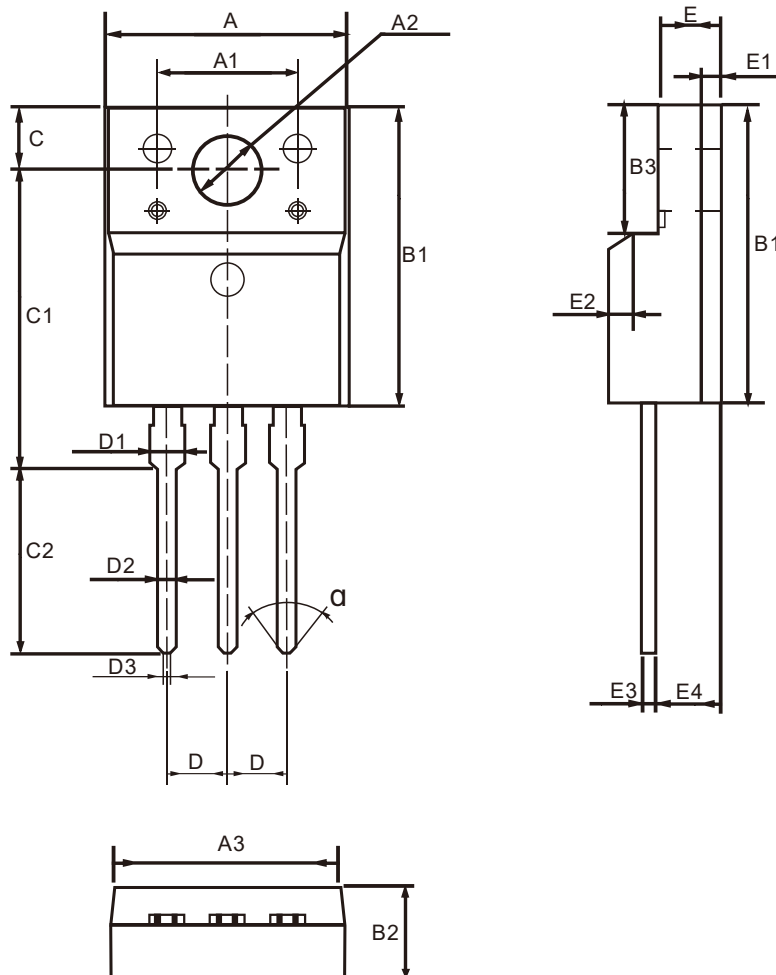

TO-220F Package Dimensions

UNIT: mm

SYMBOL	min	nom	max	SYMBOL	min	nom	max
A	9.80		10.60	D		2.54	
A1		7.00		D1	1.15		1.55
A2	2.90		3.40	D2	0.60		1.00
A3	9.10		9.90	D3	0.20		0.50
B1	15.40		16.40	E	2.24		2.84
B2	4.35		4.95	E1		0.70	
B3	6.00		7.40	E2		1.0 × 45°	
C	3.00		3.70	E3	0.35		0.65
C1	15.00		17.00	E4	2.30		3.30
C2	8.80		10.80	α (度)		30°	