



PJM80N30TE

N-Channel Enhancement Mode Power MOSFET

Product Summary

- $V_{DS} = 30V, I_D = 80A$
- $R_{DS(on)} < 5m\Omega @ V_{GS} = 10V$
- $R_{DS(on)} < 6.6m\Omega @ V_{GS} = 4.5V$

Features

- Advanced Trench Technology
- 100% Avalanche Tested
- RoHS Compliant
- Halogen and Antimony Free
- Moisture Sensitivity Level 3

Application

- Load Switch
- PWM Application
- Power management

Marking Code

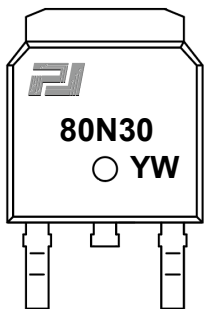

TO-252

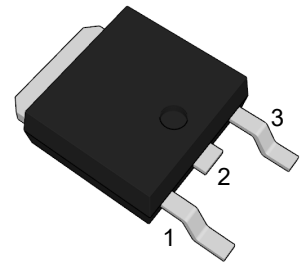

(Top View)

Pin	Description
1	Gate
2	Drain
3	Source

Schematic Diagram

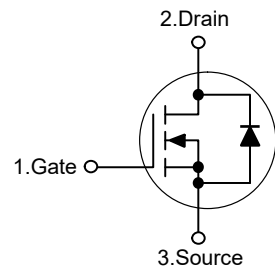

Absolute Maximum Ratings

Ratings at 25°C case temperature unless otherwise specified.

Parameter	Symbol	Value	Unit
Drain-Source Voltage	V_{DS}	30	V
Gate-Source Voltage	V_{GS}	± 20	V
Drain Current-Continuous	I_D	80	A
Drain Current-Pulsed ^{Note1}	I_{DM}	280	A
Maximum Power Dissipation	P_D	50	W
Single pulse avalanche energy ^{Note2}	E_{AS}	100	mJ
Junction Temperature	T_J	150	°C
Storage Temperature Range	T_{STG}	-55 to +150	°C

Thermal Characteristics

Thermal Resistance, Junction-to-Case	$R_{\theta JC}$	2.5	°C/W
--------------------------------------	-----------------	-----	------



PJM80N30TE

N-Channel Enhancement Mode Power MOSFET

Electrical Characteristics

($T_J=25^{\circ}\text{C}$ unless otherwise specified)

Parameter	Symbol	Test Condition	Min.	Typ.	Max.	Unit
Static Characteristics						
Drain-Source Breakdown Voltage	$V_{(BR)DSS}$	$V_{GS}=0V, I_D=250\mu A$	30	--	--	V
Zero Gate Voltage Drain Current	I_{DSS}	$V_{DS}=30V, V_{GS}=0V$	--	--	1	μA
Gate-Body Leakage Current	I_{GSS}	$V_{GS}=\pm 20V, V_{DS}=0V$	--	--	± 100	nA
Gate Threshold Voltage ^{Note3}	$V_{GS(th)}$	$V_{DS}=V_{GS}, I_D=250\mu A$	1	1.5	2.5	V
Drain-Source On-Resistance ^{Note3}	$R_{DS(on)}$	$V_{GS}=10V, I_D=30A$	--	3.8	5	m Ω
		$V_{GS}=4.5V, I_D=20A$	--	5.2	6.6	m Ω
Forward Transconductance ^{Note3}	g_{FS}	$V_{DS}=5V, I_D=1A$	--	6.5	--	S
Dynamic Characteristics						
Input Capacitance	C_{iss}	$V_{DS}=15V, V_{GS}=0V, f=1\text{MHz}$	--	2156	--	pF
Output Capacitance	C_{oss}		--	253	--	pF
Reverse Transfer Capacitance	C_{rss}		--	215	--	pF
Gate Resistance	R_g	$V_{DS}=0V, V_{GS}=0V, f=1\text{MHz}$	--	2.8	--	Ω
Total Gate Charge	Q_g	$V_{DS}=15V, I_D=30A,$ $V_{GS}=10V$	--	33.7	--	nC
Gate-Source Charge	Q_{gs}		--	8.5	--	nC
Gate-Drain Charge	Q_{gd}		--	7.5	--	nC
Switching Characteristics						
Turn-on Delay Time	$t_{d(on)}$	$V_{DD}=15V, I_D=30A,$ $V_{GS}=10V, R_{GEN}=3\Omega$	--	7.5	--	nS
Turn-on Rise Time	t_r		--	14.5	--	nS
Turn-off Delay Time	$t_{d(off)}$		--	35.2	--	nS
Turn-off Fall Time	t_f		--	9.6	--	nS
Source-Drain Diode Characteristics						
Diode Forward Voltage	V_{SD}	$V_{GS}=0V, I_S=30A$	--	--	1.2	V
Diode Forward Current	I_S		--	--	80	A

Note: 1. Repetitive Rating: Pulse Width Limited by Maximum Junction Temperature.

2. EAS Condition: $T_J=25^{\circ}\text{C}, V_{DD}=30V, V_G=10V, L=0.5\text{mH}, I_{AS}=20A$.

3. Pulse Test: Pulse Width $\leq 300\mu\text{s}$, Duty Cycle $\leq 0.5\%$.



PJM80N30TE

N-Channel Enhancement Mode Power MOSFET

Typical Characteristic Curves

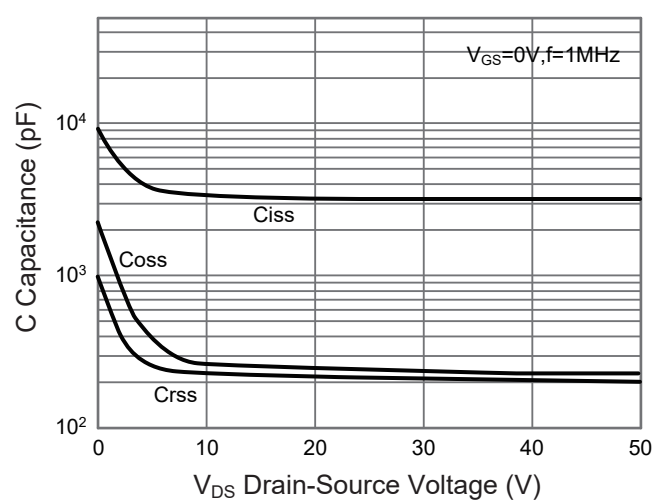
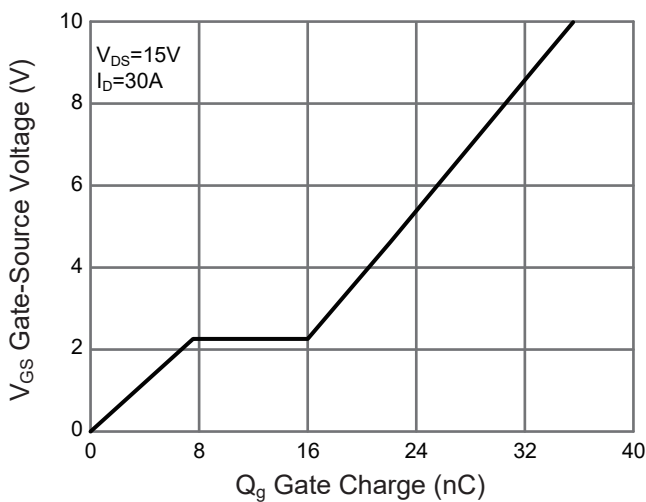
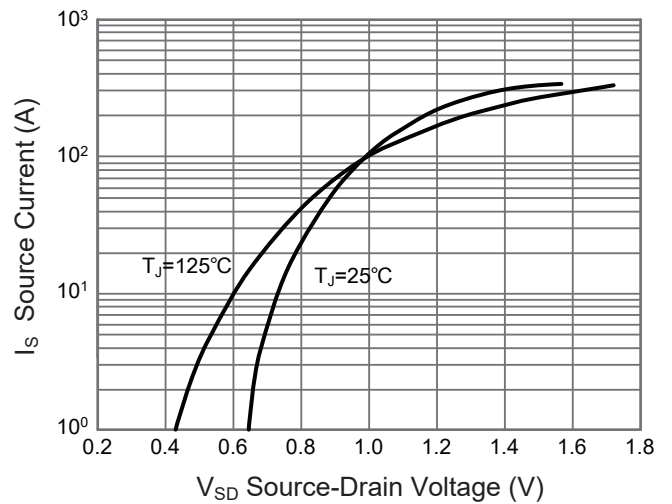
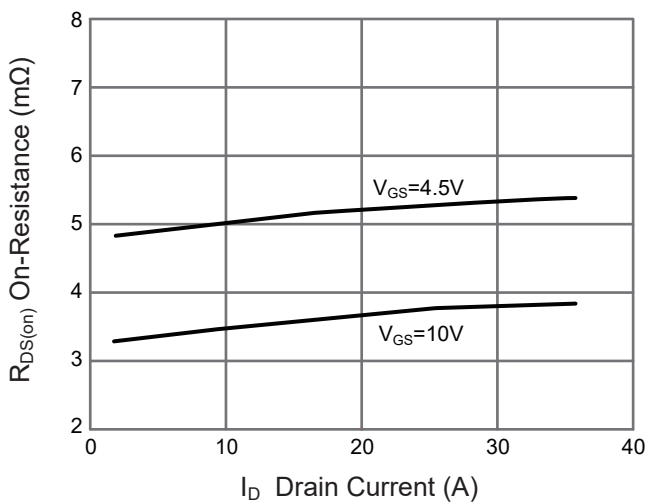
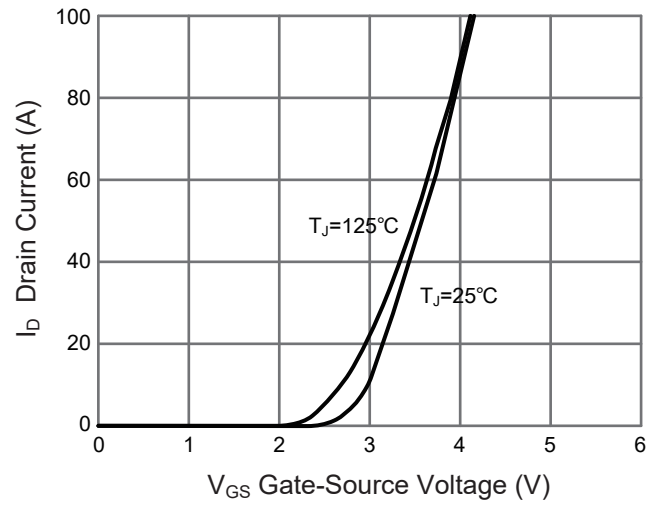
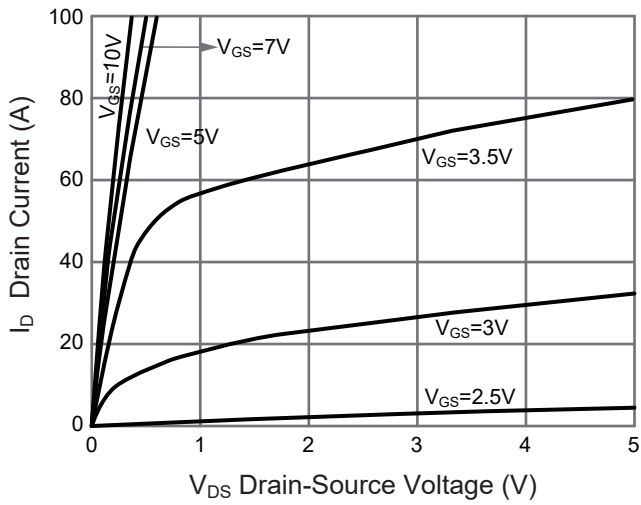



PJM80N30TE

N-Channel Enhancement Mode Power MOSFET

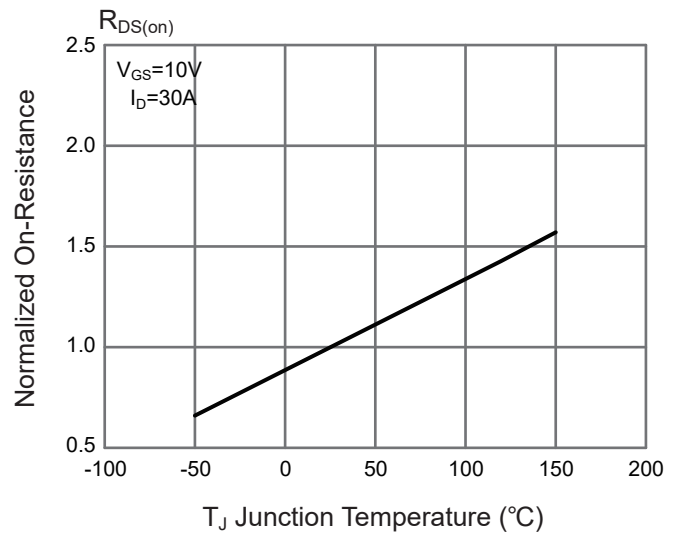
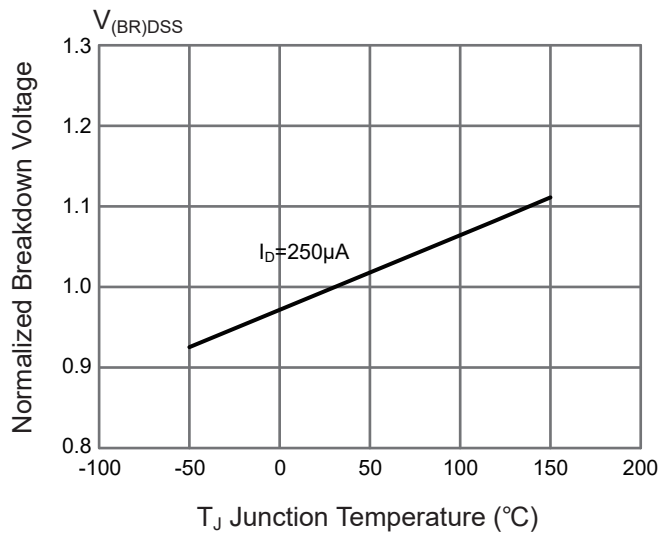



PJM80N30TE

N-Channel Enhancement Mode Power MOSFET

Package Outline

TO-252

Dimensions in mm

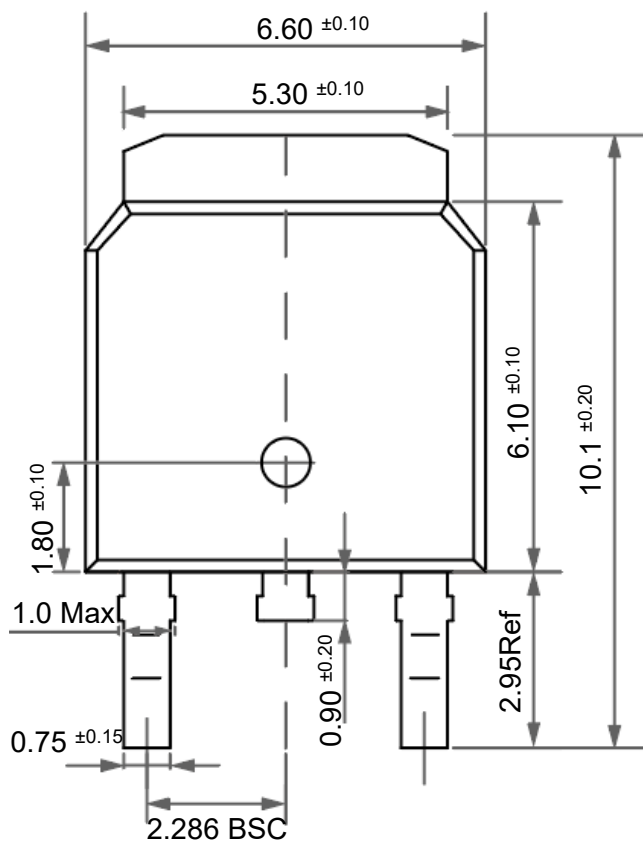

Front View

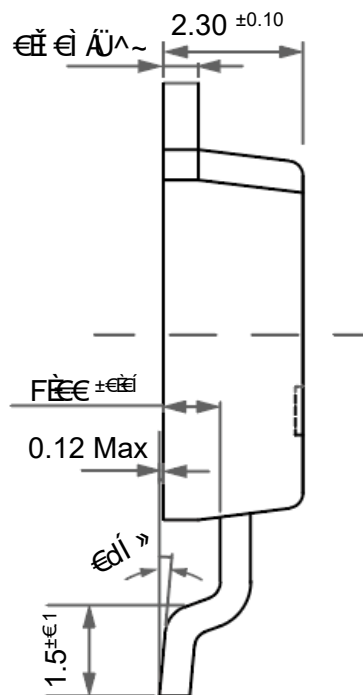

Side View

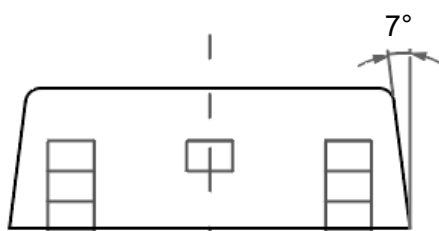

Bottom View

Ordering Information

Device	Package	Shipping
PJM80N30TE	TO-252	2,500PCS/Reel&13inches



Conditions of Soldering and Storage

◆ Recommended condition of reflow soldering

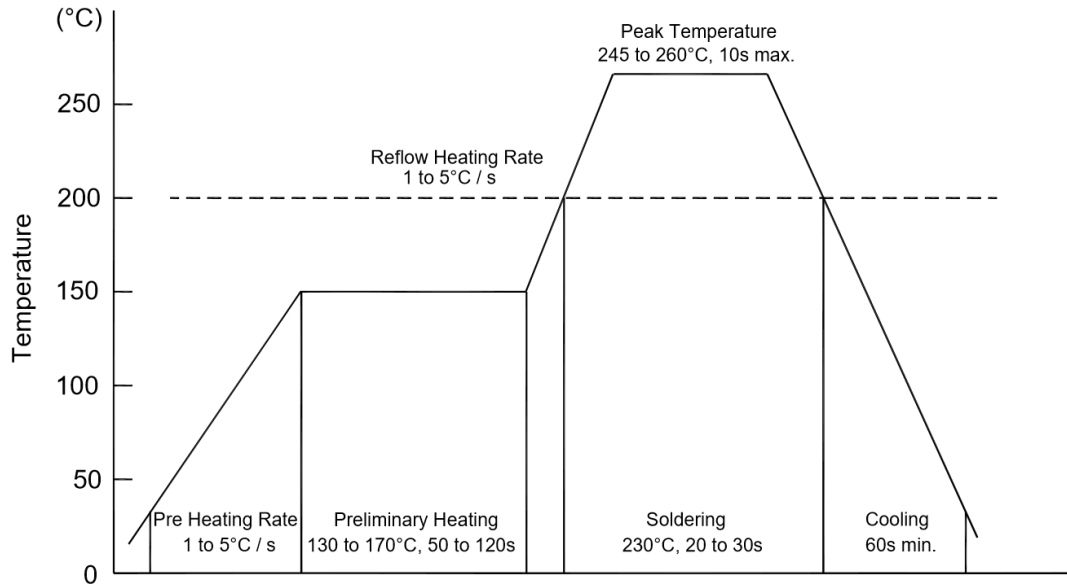

Recommended peak temperature is over 245°C. If peak temperature is below 245°C, you may adjust the following parameters:

- Time length of peak temperature (longer)
- Time length of soldering (longer)
- Thickness of solder paste (thicker)

◆ Conditions of hand soldering

- Temperature: 300°C
- Time: 3s max.
- Times: one time

◆ Storage conditions

- **Temperature**
5 to 40°C
- **Humidity**
30 to 80% RH
- **Recommended period**
One year after manufacturing

Package Specifications

- The method of packaging

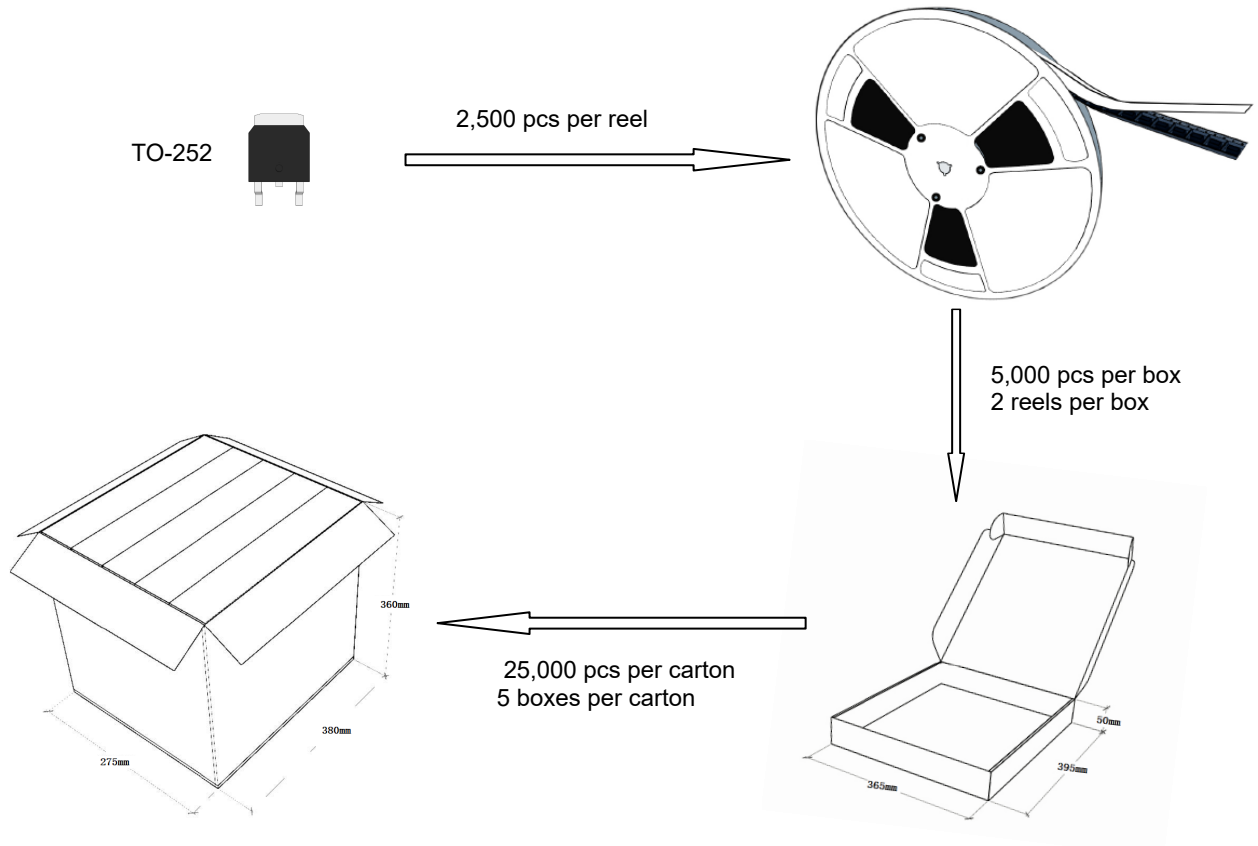

◆ reel data

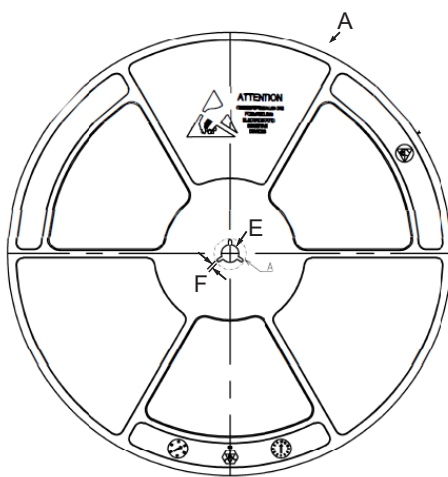

Symbol	Value(unit:mm)
A	$\Phi 330.2 \pm 1$
B	17 ± 0.5
C	21.2 ± 2
D	$\Phi 100 \pm 0.5$
E	$\Phi 13.4 \pm 0.2$
F	2.3 ± 0.2
T	2.1 ± 0.2



PJM80N30TE

N-Channel Enhancement Mode Power MOSFET

◆ Embossed tape data

