



PJ79L09SQ

3-Terminal Voltage Regulator

Features

- Input voltage: up to -30V
- Output voltage: -9V

SOT-89

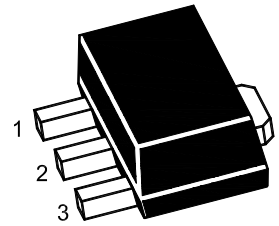

1. GND 2. VIN 3. VOUT

Marking Code : 79L09

Absolute Maximum Ratings

operating temperature range applies unless otherwise specified

Parameter	Symbol	Value	Unit
Input Voltage	$-V_I$	30	V
Junction Temperature	T_J	150	°C
Operating Temperature Range	T_{OPR}	0 to +125	°C
Storage Temperature Range	T_{STG}	-65 to +150	°C

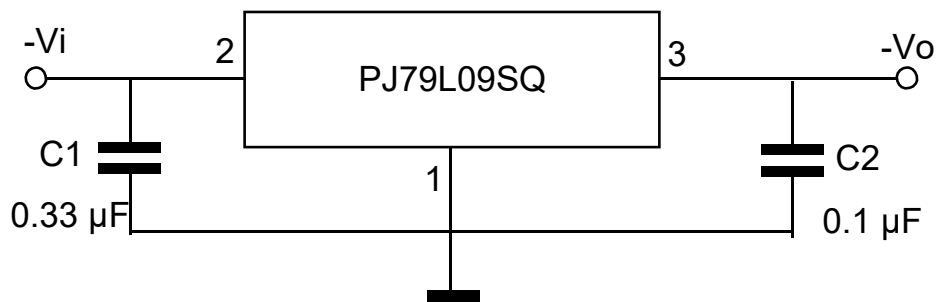



PJ79L09SQ

3-Terminal Voltage Regulator

Electrical Characteristics

$T_J=25^{\circ}\text{C}$, $C_i=0.33\mu\text{F}$, $C_o=1.0\mu\text{F}$, unless otherwise specified.

Parameter	Symbol	Test Conditions	Min.	Typ.	Max.	Unit
Output Voltage	$-V_o$	$V_i=-15\text{V}, I_o=40\text{mA}$	8.64	9.0	9.36	V
Line Regulation	ΔV_o	$V_i=-12.5\sim-24\text{V}, I_o=40\text{mA}$	--	27	200	mV
Load Regulation	ΔV_o	$V_i=-15\text{V}, I_o=1\sim 100\text{mA}$	--	12	90	mV
Ripple Rejection	RR	$V_i=-12\text{V to }-22\text{V}$ $f=150\text{Hz}, I_o=40\text{mA}, e_{in}=1\text{Vp-p}$	38	67	--	dB
Quiescent Current	I_q	$V_i=-15\text{V}, I_o=40\text{mA}$	--	2.0	6.0	mA
Output Noise Voltage	V_N	$V_i=-15\text{V}, I_o=40\text{mA}$ $10\text{Hz}\leq f\leq 100\text{KHz}$	--	210	--	μV



PJ79L09SQ

3-Terminal Voltage Regulator

Typical Characteristic Curves

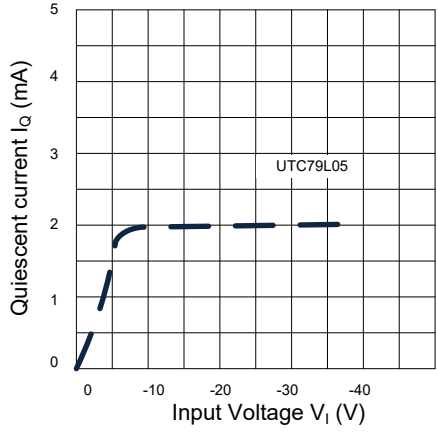
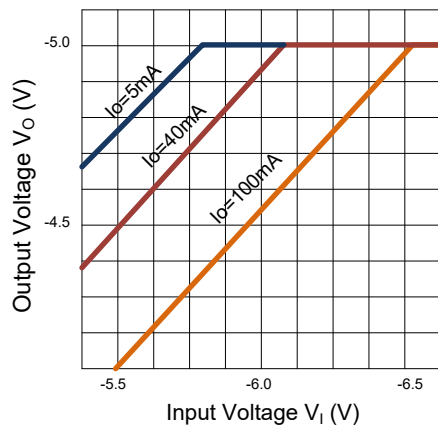
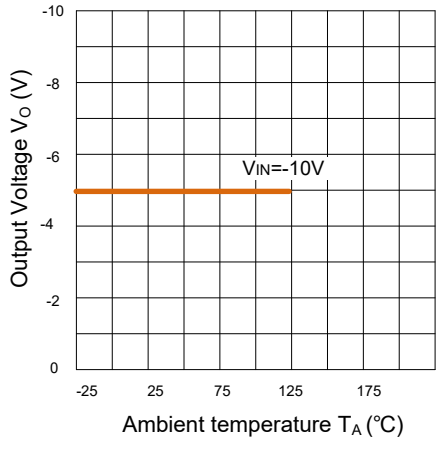
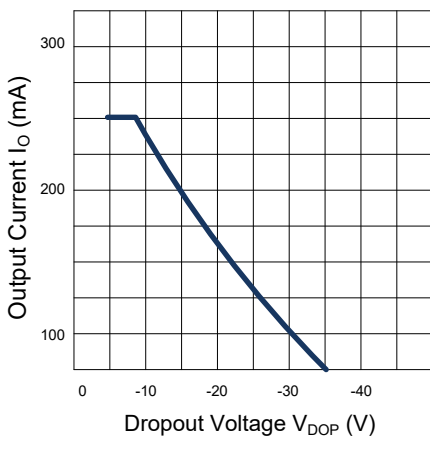
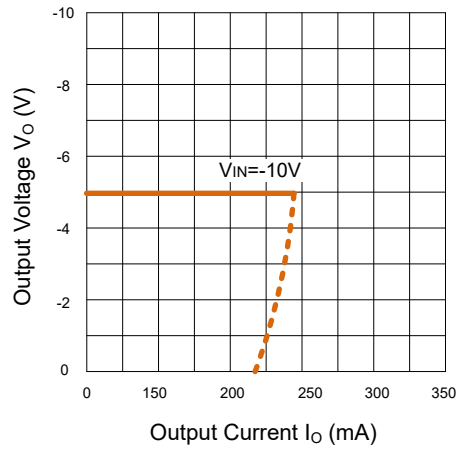
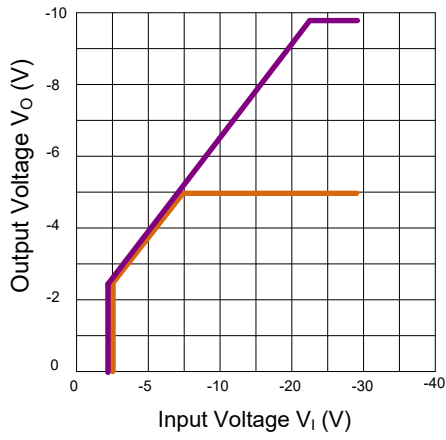



PJ79L09SQ

3-Terminal Voltage Regulator

Package Outline

SOT-89

Dimensions in mm

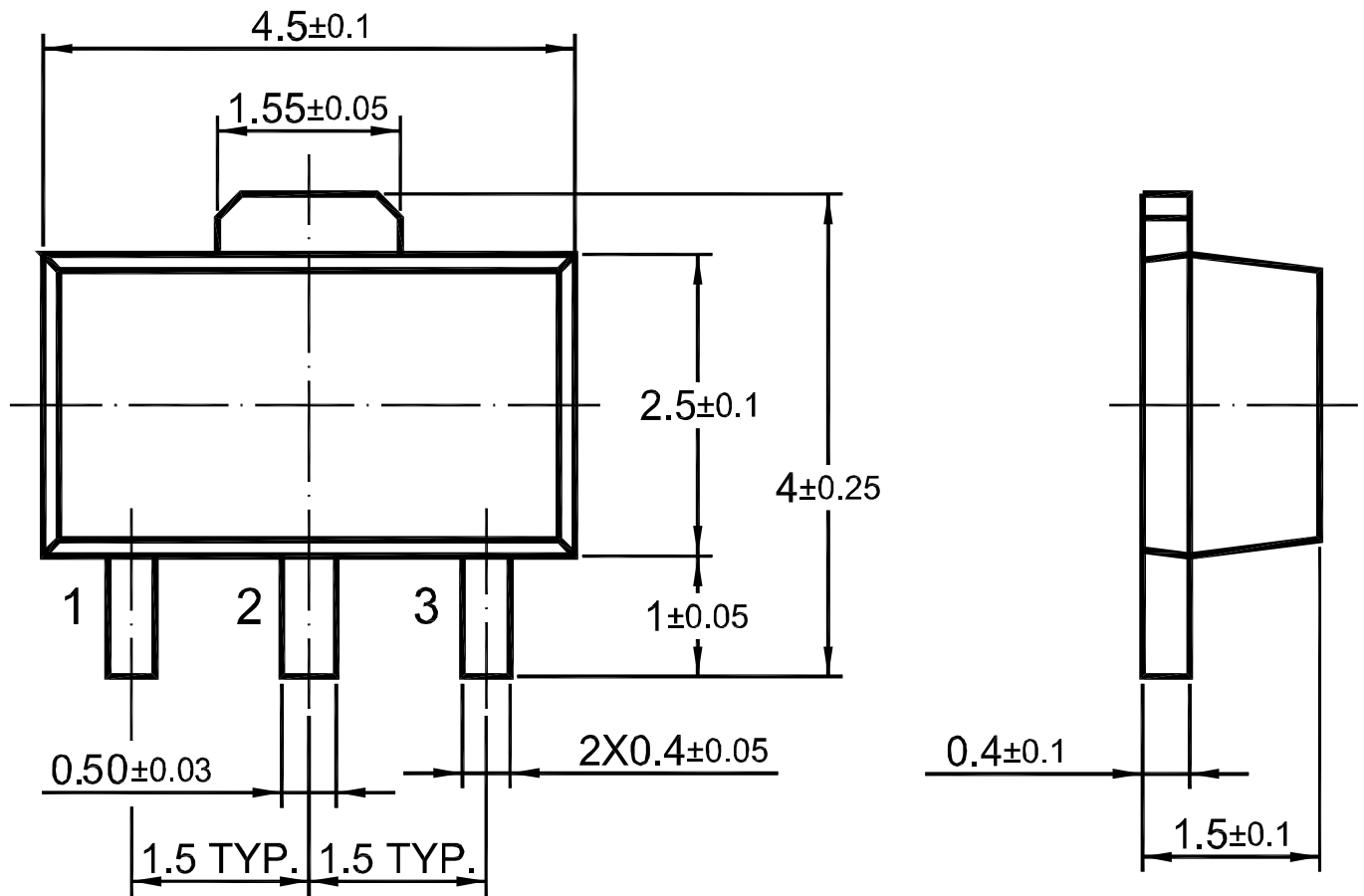

Ordering Information

Device	Package	Shipping
PJ79L09SQ	SOT-89	1,000PCS/Reel&7inches
		3,000PCS/Reel&13inches