



PJ78S05SQ

3-Terminal Voltage Regulator

Features

- Input voltage: up to 35V
- Output voltage: 5V
- Output current up to 200 mA, internal thermal overload protection and short-circuit current limiting.

SOT-89

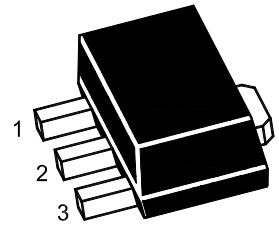

1. VOUT 2. GND 3. VIN

Marking Code : 78S05

Absolute Maximum Ratings

Ratings at 25°C ambient temperature unless otherwise specified.

Parameter	Symbol	Value	Unit
Input Voltage	V_I	35	V
Output Current	I_O	200	mA
Maximum Power Dissipation	P_D	500	mW
Thermal Resistance Junction-Air	$R_{\theta JA}$	250	°C/W
Junction Temperature	T_J	150	°C
Operating Temperature Range	T_{OPR}	-40 to +125	°C
Storage Temperature Range	T_{STG}	-55 to +150	°C

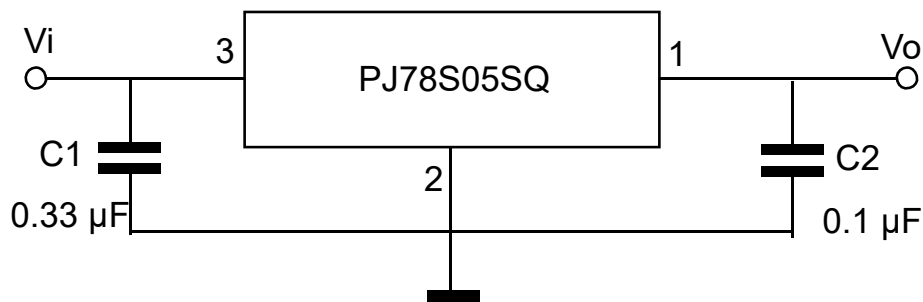



PJ78S05SQ

3-Terminal Voltage Regulator

Electrical Characteristics

Ratings at $0^{\circ}\text{C} \leq T_J \leq 125^{\circ}\text{C}$, $V_I = 10\text{V}$, $I_O = 40\text{mA}$, $C_I = 0.33\mu\text{F}$, $C_O = 0.1\mu\text{F}$, unless otherwise specified.

Parameter	Symbol	Test Conditions	Min.	Typ.	Max.	Unit
Output Voltage	V_O	$T_J = 25^{\circ}\text{C}$	4.80	5.0	5.2	V
		$I_O = 1\text{mA to } 40\text{mA}$, $V_I = 7\text{V to } 20\text{V}$	4.75	5.0	5.25	V
		$I_O = 1\text{mA to } 70\text{mA}$, $V_I = 10\text{V}$	4.75	5.0	5.25	V
Line Regulation	ΔV_O	$V_I = 7\text{V to } 20\text{V}$, $T_J = 25^{\circ}\text{C}$	--	8	150	mV
		$V_I = 8\text{V to } 20\text{V}$, $T_J = 25^{\circ}\text{C}$	--	6	100	mV
Load Regulation	ΔV_O	$I_O = 1\text{mA to } 100\text{mA}$, $T_J = 25^{\circ}\text{C}$	--	11	60	mV
		$I_O = 1\text{mA to } 40\text{mA}$, $T_J = 25^{\circ}\text{C}$	--	5	30	mV
Ripple Rejection	RR	$V_I = 8\text{V to } 20\text{V}$, $f = 120\text{Hz}$, $T_J = 25^{\circ}\text{C}$	40	49	--	dB
Dropout Voltage	V_D	$T_J = 25^{\circ}\text{C}$	--	1.7	--	V
Quiescent Current	I_Q		--	2	5.5	mA
Quiescent Current Change	ΔI_Q	$V_I = 8\text{V to } 20\text{V}$	--	--	1.5	mA
		$I_O = 1\text{mA to } 40\text{mA}$	--	--	0.1	mA
Output Noise Voltage	V_N	$10\text{Hz} \leq f \leq 100\text{KHz}$	--	40	--	μV



PJ78S05SQ

3-Terminal Voltage Regulator

Typical Characteristic Curves

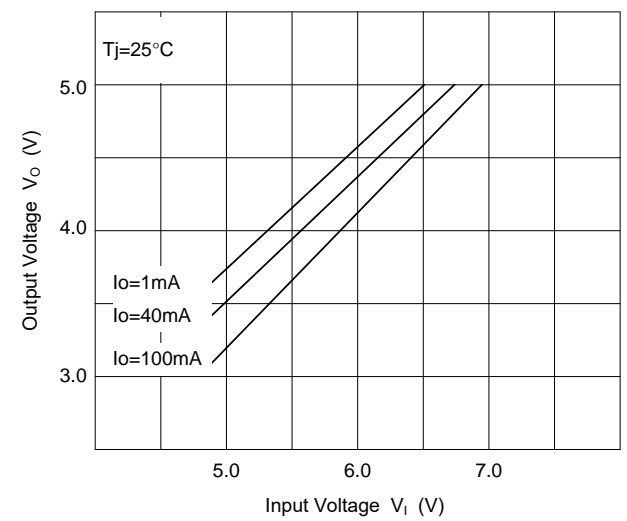
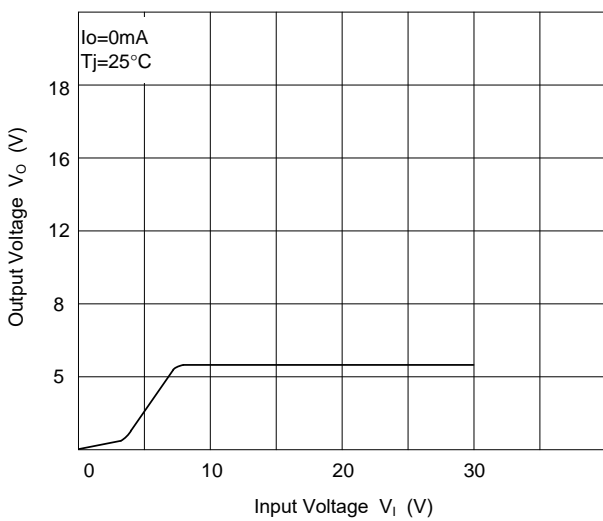
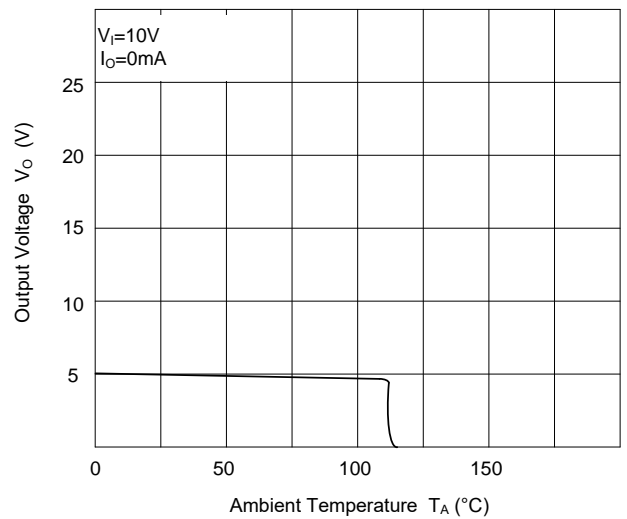
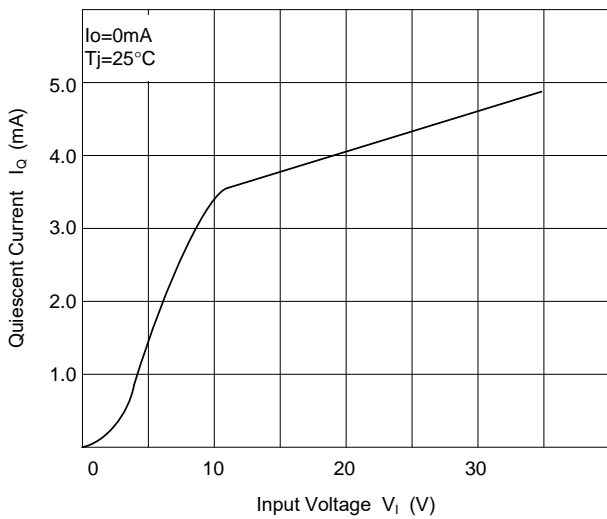
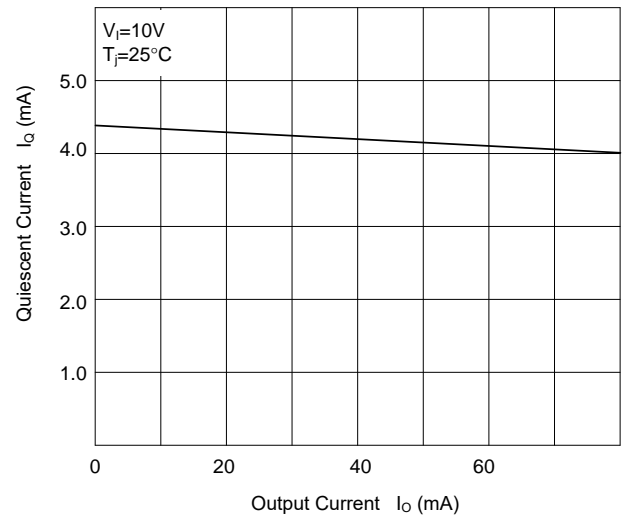
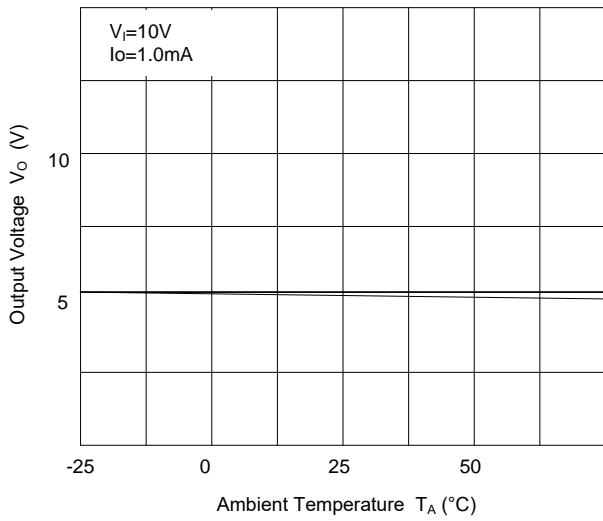



PJ78S05SQ

3-Terminal Voltage Regulator

Package Outline

SOT-89

Dimensions in mm

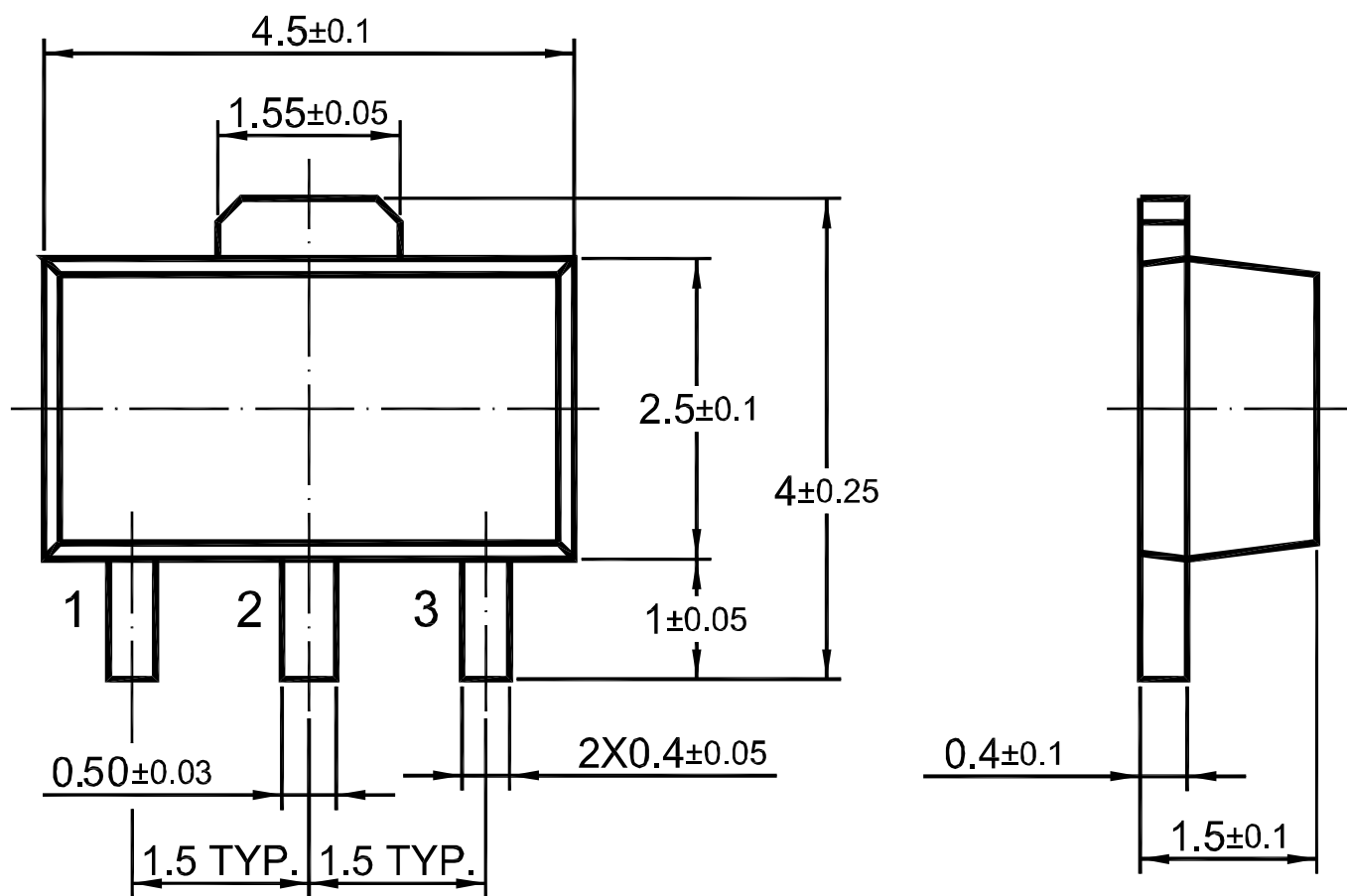

Ordering Information

Device	Package	Shipping
PJ78S05SQ	SOT-89	1,000PCS/Reel&7inches
		3,000PCS/Reel&13inches