



# PJ78M05TE-S

## 3-Terminal Voltage Regulator

### Features

- Input voltage: up to 30V
- Output voltage: 5V
- Output current up to 500 mA, internal thermal overload protection and short-circuit current limiting.

TO-252

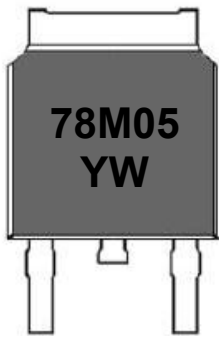

1. VIN 2. GND 3. VOUT

		Marking code										
		78M05: Product code										
	78M05 YW	Y: Year code	2022	2023	2024	2025	2026	2027	2028	2029	2030	2031
			G	H	J	K	A	B	C	D	E	F
	W: Week code	Weeks	1~26			27~52			53			
		code	A~Z			a~z			z			

### Absolute Maximum Ratings

Ratings at 25°C ambient temperature unless otherwise specified.

Parameter	Symbol	Value	Unit
Input Voltage	$V_i$	30	V
Thermal Resistance, Junction-to-Air	$R_{\theta JA}$	83	°C/W
Operating Temperature Range	$T_{OPR}$	-40 to +125	°C
Storage Temperature Range	$T_{STG}$	-40 to +150	°C

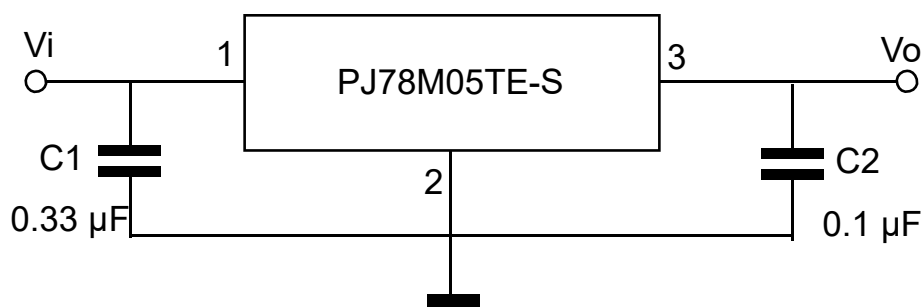



# PJ78M05TE-S

## 3-Terminal Voltage Regulator

### Electrical Characteristics

Ratings at  $V_I=10V, I_O=350mA, C_I=0.33\mu F, C_O=0.1\mu F$ , With heat sink, unless otherwise specified.

Parameter	Symbol	Test Conditions	Min.	Typ.	Max.	Unit
Output Voltage	$V_O$	$V_I=10V, I_O=250mA$	4.8	5.0	5.2	V
		$V_I=7V \text{ to } 20V, 5mA \leq I_O \leq 350mA$	4.780	5.0	5.220	
Line Regulation	$\Delta V_O$	$V_I=7V \text{ to } 20V, I_O=350mA$	--	--	50	mV
Load Regulation	$\Delta V_O$	$V_I=10V, 5mA \leq I_O \leq 200mA$	--	--	50	mV
		$V_I=10V, 5mA \leq I_O \leq 500mA$	--	--	100	mV
Dropout Voltage	$V_D$	$I_O=350mA$	--	2	--	V
Quiescent Current	$I_Q$		--	--	6	mA
Quiescent Current Change	$\Delta I_Q$	$V_I=10V, 5mA \leq I_O \leq 350mA$	--	--	0.5	mA
		$8V \leq V_I \leq 25V, I_O=200mA$	--	--	0.8	mA
Supply Current	$I_{CC}$	$V_I=35V, I_O=0mA$	--	--	9	mA



# PJ78M05TE-S

## 3-Terminal Voltage Regulator

### Typical Characteristic Curves

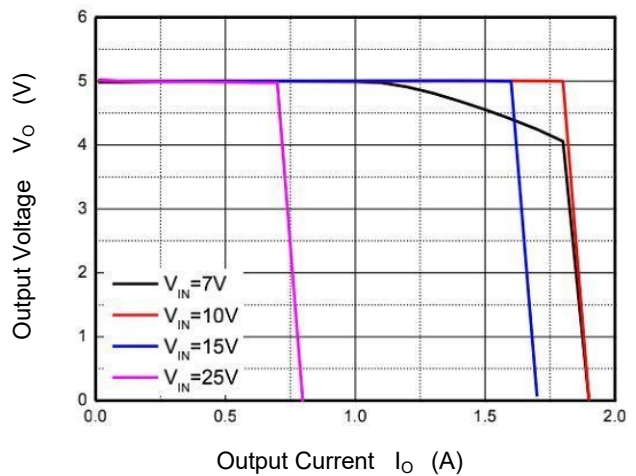
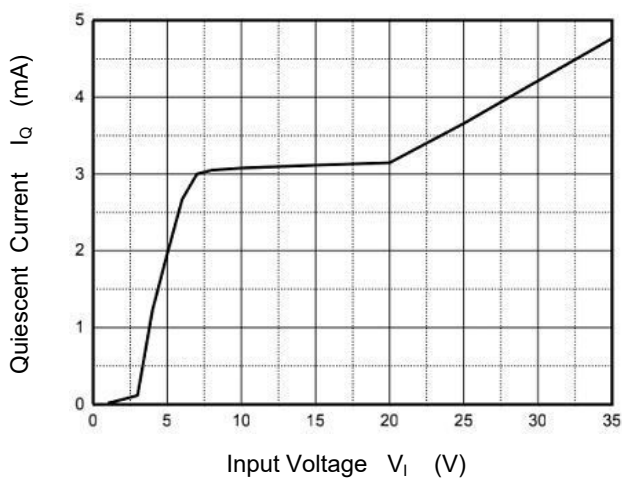
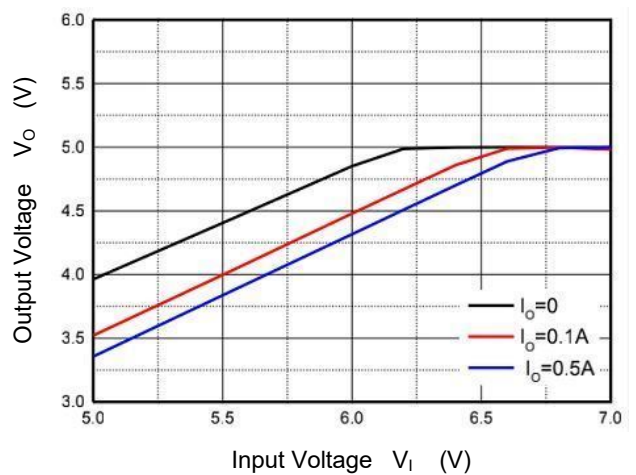
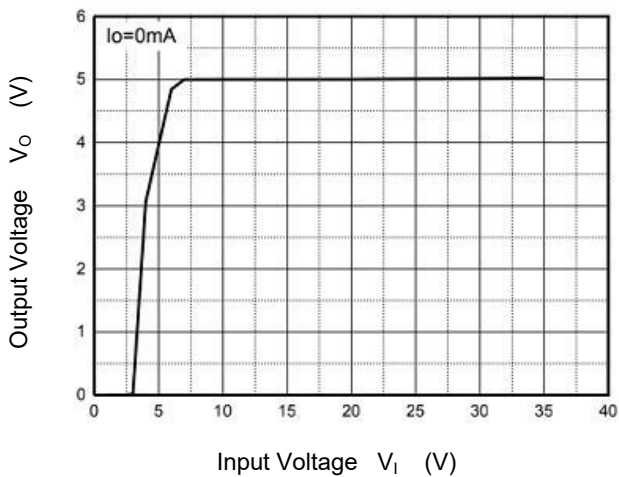
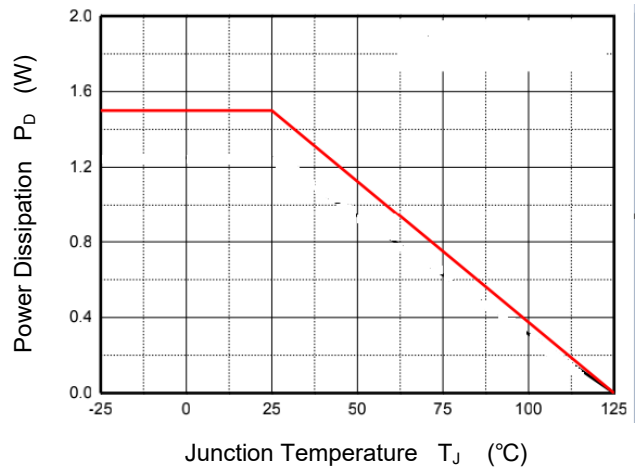
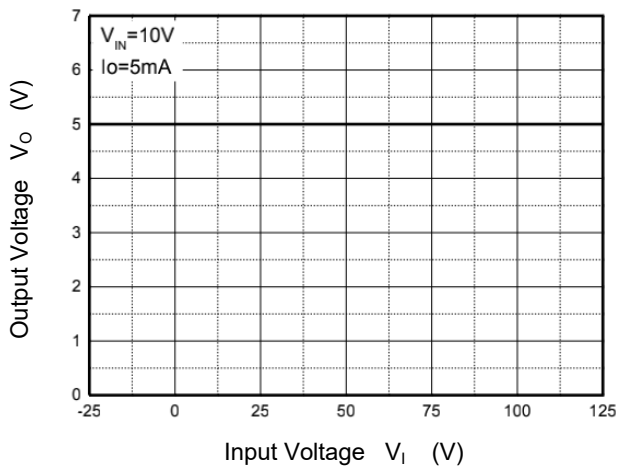



# PJ78M05TE-S

## 3-Terminal Voltage Regulator

### Package Outline

TO-252

Dimensions in mm

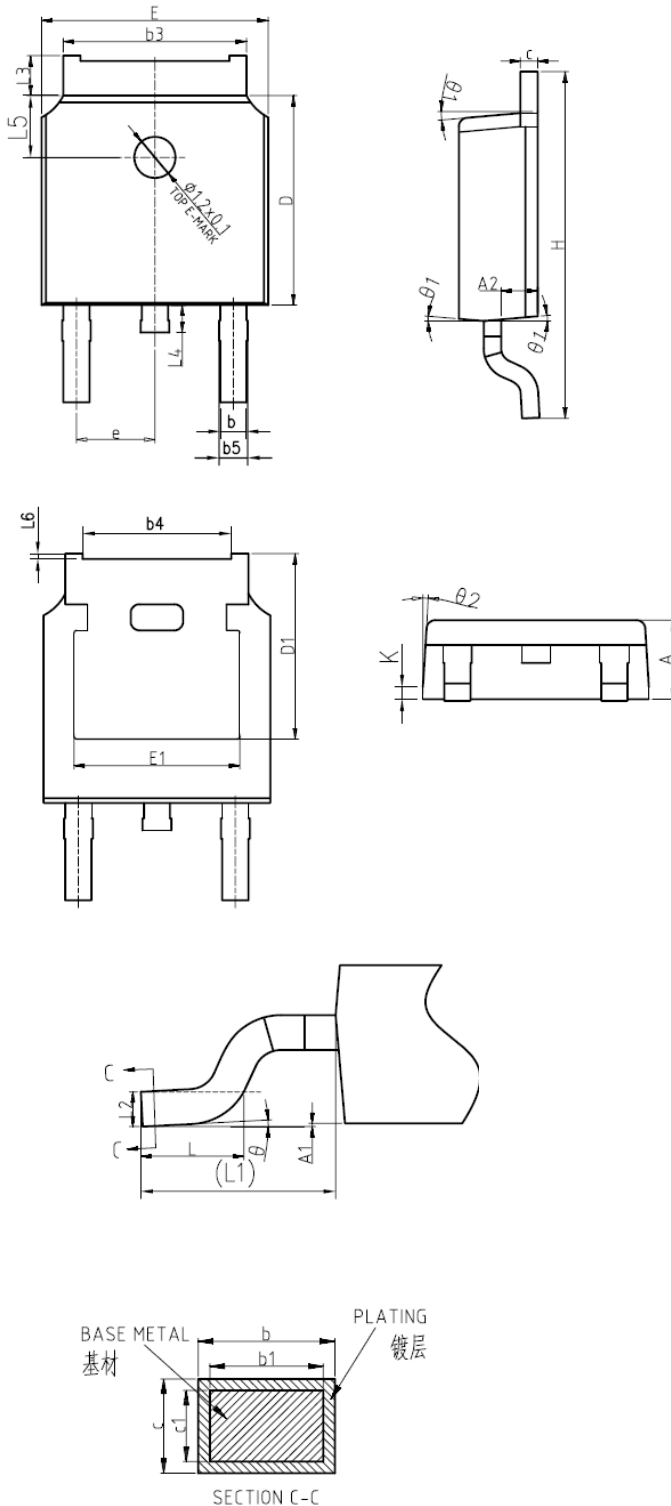

Symbol	mm		
	Min.	Nom.	Max.
*A	2.20	2.30	2.38
*A1	0.00	--	0.10
A2	0.97	1.07	1.17
*b	0.72	0.78	0.85
b1	0.71	0.76	0.81
*b3	5.23	5.33	5.46
b4	4.27	4.32	4.37
b5	0.72	0.88	0.93
*c	0.47	0.53	0.58
c1	0.46	0.51	0.56
*D	6.00	6.10	6.20
D1	5.30REF		
*E	6.50	6.60	6.70
E1	4.70	4.83	4.92
*e	2.286BSC		
*H	9.90	10.10	10.30
L	1.40	1.50	1.70
L1	2.90REF		
L2	0.51BSC		
*L3	0.90	--	1.25
*L4	0.60	0.80	1.00
L5	1.70	1.80	1.90
L6	0	0.047	0.123
θ	0°	--	8°
*θ1	5°	7°	9°
θ2	5°	7°	9°
K	0.40REF		
带*为检验尺寸			

### Ordering Information

Device	Package	Shipping
PJ78M05TE-S	TO-252	2,500PCS/Reel&13inches