



# PJ78L09SQ

## 3-Terminal Voltage Regulator

### Features

- Input voltage: up to 30V
- Output voltage: 9V
- Output current up to 100 mA, internal thermal overload protection and short-circuit current limiting.

### SOT-89

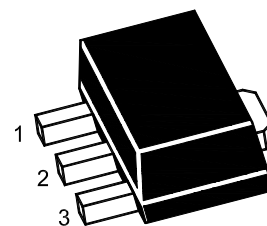

1. VOUT 2. GND 3. VIN

Marking Code : 78L09

### Absolute Maximum Ratings

Ratings at 25°C ambient temperature unless otherwise specified.

Parameter	Symbol	Value	Unit
Input Voltage	$V_I$	30	V
Output Current	$I_O$	100	mA
Maximum Power Dissipation	$P_D$	500	mW
Junction Temperature	$T_J$	150	°C
Operating Temperature Range	$T_{OPR}$	-40 to +125	°C
Storage Temperature Range	$T_{STG}$	-55 to +150	°C

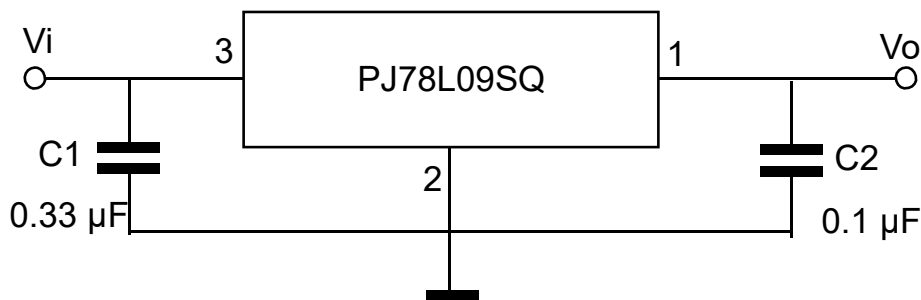



# PJ78L09SQ

## 3-Terminal Voltage Regulator

### Electrical Characteristics

$V_i=15V$ ,  $I_o=40mA$ ,  $0^{\circ}C \leq T_J \leq 125^{\circ}C$ ,  $C_i=0.33\mu F$ ,  $C_o=0.1\mu F$ , unless otherwise specified.

Parameter	Symbol	Test Conditions	Min.	Typ.	Max.	Unit
Output Voltage	$V_o$	$T_J=25^{\circ}C$	8.64	9	9.36	V
		$I_o=1mA$ to $40mA$ , $V_i=11.5V$ to $24V$	8.55	9	9.45	V
		$I_o=1mA$ to $70mA$	8.55	9	9.45	V
Line Regulation	$\Delta V_o$	$V_i=11.5V$ to $24V$ , $T_J=25^{\circ}C$	--	--	200	mV
		$V_i=13V$ to $24V$ , $T_J=25^{\circ}C$	--	--	150	mV
Load Regulation	$\Delta V_o$	$I_o=1mA$ to $100mA$ , $T_J=25^{\circ}C$	--	--	90	mV
		$I_o=1mA$ to $40mA$ , $T_J=25^{\circ}C$	--	--	45	mV
Ripple Rejection	RR	$V_i=12V$ to $23V$ , $f=120Hz$ , $T_J=25^{\circ}C$	36	44	--	dB
Dropout Voltage	$V_D$	$T_J=25^{\circ}C$	--	1.7	--	V
Quiescent Current	$I_Q$		--	--	5.5	mA
Quiescent Current Change	$\Delta I_Q$	$V_i=13V$ to $24V$	--	--	1.5	mA
		$I_o=1mA$ to $40mA$	--	--	0.1	mA
Output Noise Voltage	$V_N$	$10Hz \leq f \leq 100KHz$	--	49	--	$\mu V$



# PJ78L09SQ

## 3-Terminal Voltage Regulator

### Typical Characteristic Curves

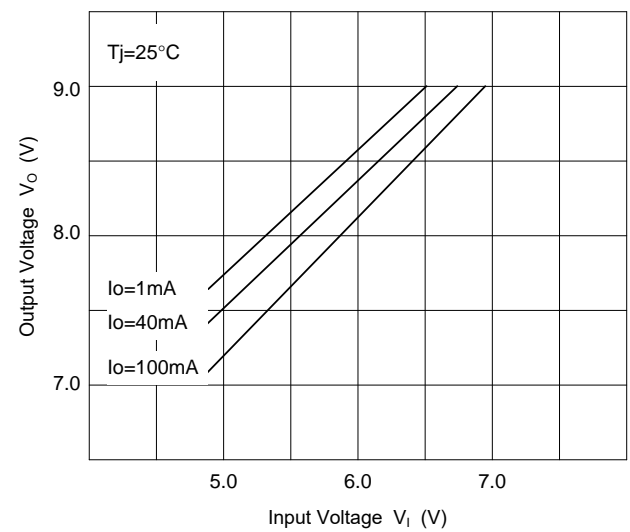
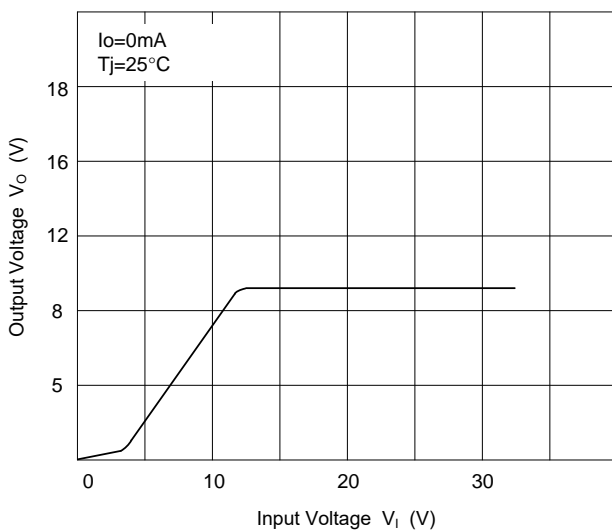
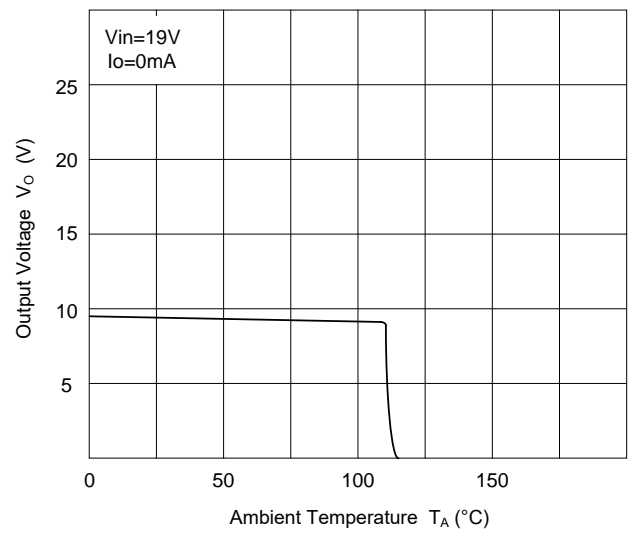
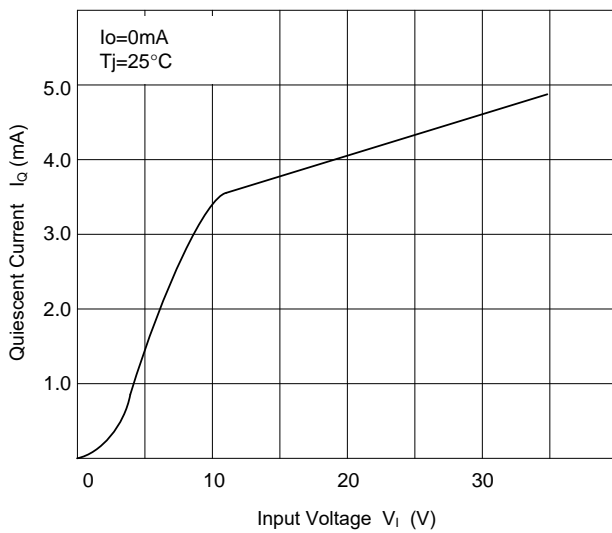
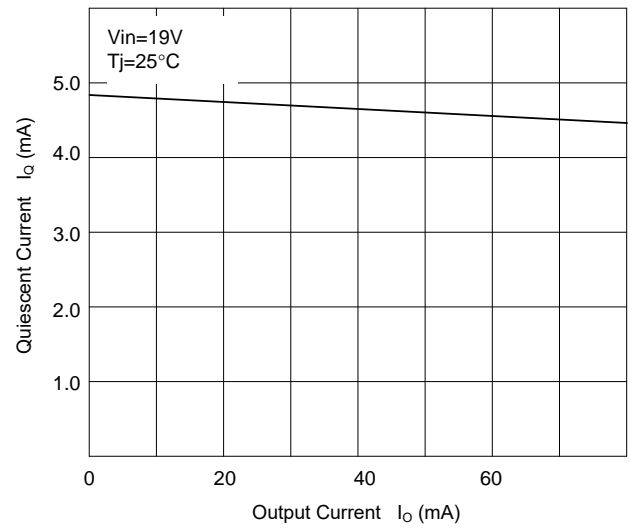
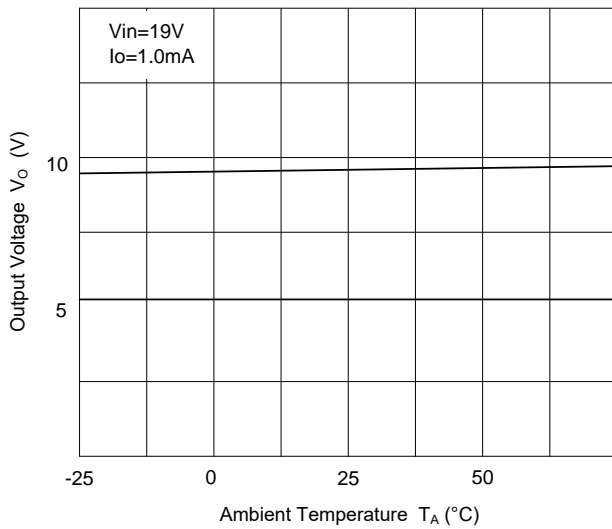



# PJ78L09SQ

## 3-Terminal Voltage Regulator

### Package Outline

SOT-89

Dimensions in mm

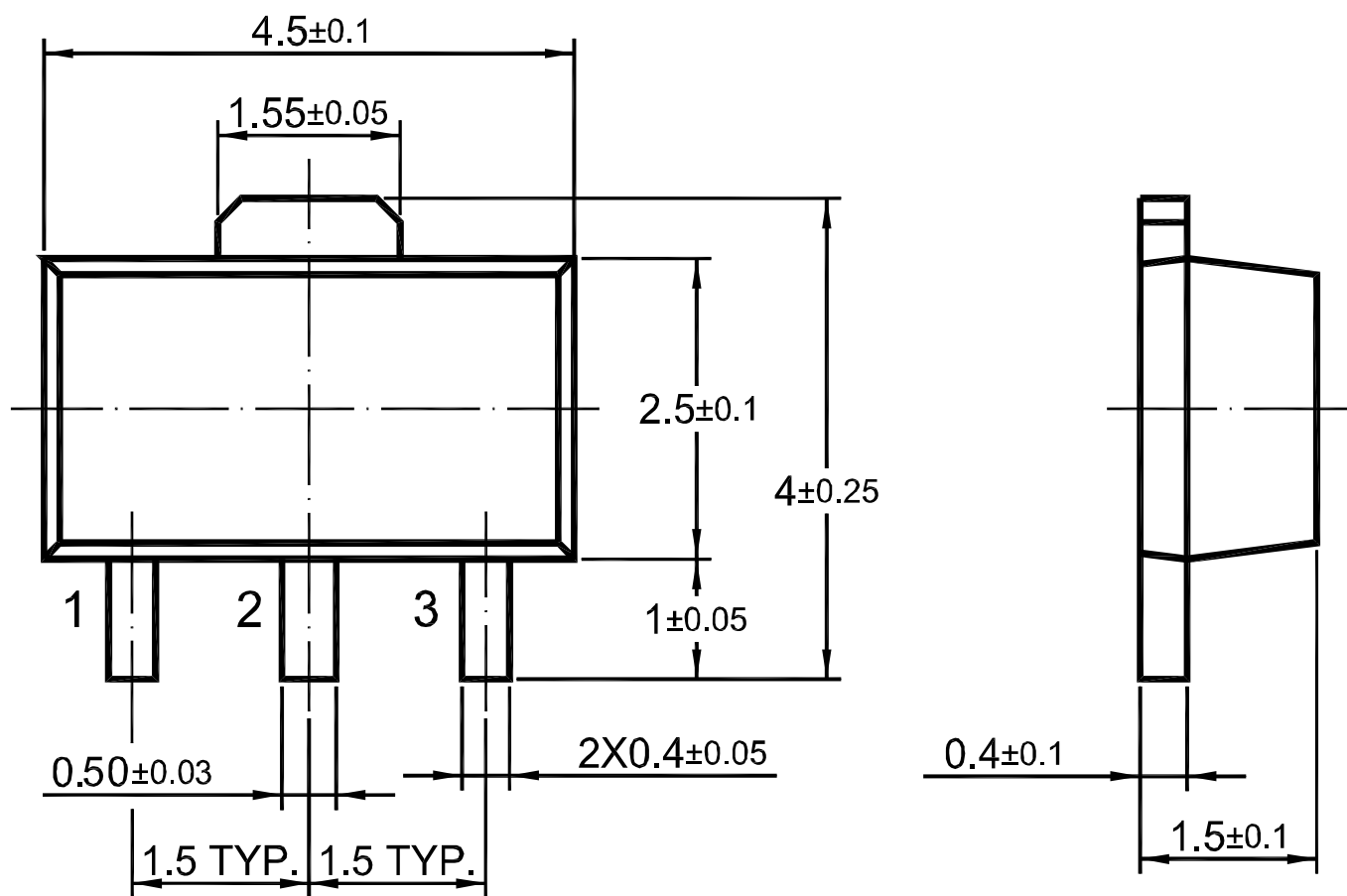

### Ordering Information

Device	Package	Shipping
PJ78L09SQ	SOT-89	1,000PCS/Reel&7inches
		3,000PCS/Reel&13inches